



An Indo Italian Joint Venture

Noir AX

Sistema
System 45



Serie Civili - Domestic Series

Controls-Switches

▼ One way switches



45301
Single pole
switch.
20AX



45310
2 Pole
switch.
20AX



45301G
Switch with
indicator.
20AX



45310L
2 pole
switch with
indicator.
20AX



45101
Single pole
switch large.
20AX

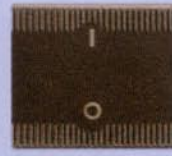

45110
2 pole
switch
large. 20AX



45373
2 pole
switch with
key. 16A



45302
2 way
switch.
20AX



45302G
2 way
switch with
indicator.
20AX



45102
2 way
switch large.
20AX



45322R
Emergency
2 pole
switch (Red)

▼ Two way switches

▼ Changeover switches



45405LV
Green light-up
push button



45405LR
Red light-up
push button



45401C
Rotating changeover
switch. 10A



45401K2
Rotating changeover
key switch 1-0-2
(with spare key). 10A



45405ER
Emergency switch with
key lock and breakable
glass. 10A



45368
LUCE AMICA-
passive infrared
detector for light
switching-on.
200 W

Presence L ▼ Light switch presence

Signals

▼ Lens indicator's



45345
Emc
mains filter



45337TR
Transparent
lens for
French base
lamps



45337VE
Green lens
for French
base lamps



45337RS
Red lens
for French
base lamps



45376
Pyramid lens
for French
base lamp



45367
Red+Green
lens for French
base lamp



45300-0
Blank insert
lens



45300-RS
Red insert
lens



45300-VE
Green insert
lens



45300-TR
Transparent
insert lens

0220
Long-life French
clear indicator
lamp with wires



45300-1
Diffuser insert
with bell
symbol



45300-2
Diffuser insert
with key
symbol



45300-3
Diffuser insert
with lamp
symbol

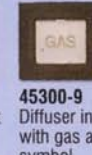

45300-9
Diffuser insert
with gas alarm
symbol

Anti-burglar Systems

▼ Relays



45349L
Light
dimmer with
large rocker
for push control.
500 W



45348-N
Light Dimmer
large. 450 W



45346-N
EME fan regulator



45374
Bistable static
noiseless
stepping relay



45375
Bistable static
noiseless large rocker
stepping relay



45369
Electro-
mechanical
monostable
relay



AF45342
Digital key reader
for control panel
with signalling LED



AF45339
Digital
programmable
key



AF45339
Digital
programmable
key



AF45341
Electronic
Key reader



AF53893
Electronic key
decoder
for use with
AF45341 & AF45339

Noir AX



CS IMQ



KONCAR



▼ Push buttons



45305
Push button
20AX



45305G
Push button.
with indicator.
20AX



45105
Push button
large.20AX



45317
Pull-cord
push button.
20AX



45305S
Push button
with bell
symbol.
20AX



45356
Double
push button
with directional
arrow.16A



45388S
Push button
with name
plate.20AX



45105R
Emergency
push button
large. 20AX
(Red)



45364R
Double pole
switch with
pilot lamp +
1 blank modul
complete with
frame. 45A
4 mod.

Detectors
Switching-on
detectors

Sockets

▼ Socket-Outlets



45368-500
LUCE AMICA-
passive infrared
detector for light
switching-on.
500 W



45306TS
International
socket-outlet
shuttered
opening.
10A, 2P+E



45333S
Euroamerican
socket-outlet
shuttered
opening.
10A, 2P+E



45397TS
English standard
flat pin socket-outlet
shuttered opening.
13A, 2P+E



45390-N
Indian standard
multipin socket.
6A, 2P+E



45392-N
Indian standard
socket.
6/16A, 2P+E



4533RS
Euroamerican shaver socket
with insulating transformer



45391
Single
coaxial outlet
40 + 862Mhz

▼ TV SAT-O

▼ Bells



45370
Step signalling lamp



45786
LUCE SICURA:
Emergency
portable plug-in lamp
with rechargeable and
replaceable batteries



45328
Electro-
mechanical
bell.12V
45330
Buzzer.12V



45329
Electro-
mechanical
bell. 230V
45331
Buzzer. 230V



45383
3 tone Electronic
bell + 5 different
sounds to be
selected separately.
12V



45340
Loudspeaker
volume
control



45342-2
Loudspeaker
double
socket
outlet



45358
4 pole
changeover
switch
for sound
diffusion



VS001
Sound diffusion loudspeaker

▼ Sound diffusion systems

▼ Sirens



AF45399
Auxiliary flush-mounting
siren alarm. 12Vdc



AF45MX99
Indoor flush-mounting
siren.12Vdc

▼ Detectors



AF45360
Flush- mounting
standard PIR
detector without
current
demand.
12V



AF45357
Dual technology,
infrared + microwave
detector.12V



45184/G
LPG gas detectors.
12V



RG1-G
Wall mounted LPG gas
detector. 230V

▼ Gas detectors

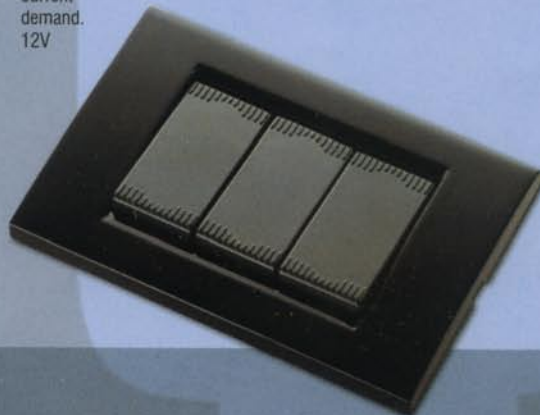

Intermediate switches ▼ Blank inserts



45304 Intermediate switch. 20AX
45308 Outlet
45313 Blank insert

Changeover switches ▼ Industrial Controls



45313R Blank insert
45351 1 Pole, 2 way switch with directional arrows. 10A
45352 2 pole, 2 way switch with directional arrows. 10A

▼ Push buttons



45401K1 Key, 0-1 switch with spare key
45405 Mushroom head push button with locking device
45405L Mushroom head push button with locking device, lightable

▼ Telephone Outlets



45396S Shielded coaxial TV/SAT outlet. Female connector + current passage 4÷2400Mhz
45324 RJ11 telephone outlet with screw terminals. 4 pin
45326 RJ12 telephone outlet with screw terminals. 6 pin
45326CR RJ12 shielded telephone outlet with crimping terminals. 4/6 pin

▼ Data outlets and connectors

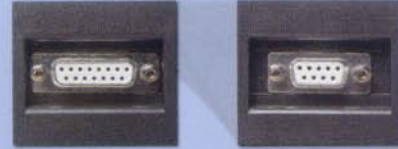

45328CR RJ45 shielded telephone outlet Cat5, 8+1 pin
45328C5 RJ45 unshielded telephone outlet Cat5, 8 pin
45380C Welding connector outlet. 15 pin
45384C Welding connector outlet. 9 pin

Protection Devices

▼ MCB's ▼ RCCB's ▼ Protections



45311Nx6 MCB switch, 1P+N 6A
45311NX10 MCB switch, 1P+N 10A
45311Nx16 MCB switch, 1P+N 16A
45322x6 RCCB switch, 1P+N 6A
45322X10 RCCB switch, 1P+N 10A
45322x16 RCCB switch, 1P+N 16A
45344 Over-voltage surge protector with pilot lamp

▼ Temperature Control Devices Thermostats



45385 Electronic high precision thermostat for heating and cooling systems. 5A
45385SW Electronic high precision thermostat with summer/winter selection switch for heating and cooling systems. 5A

▼ Timers ▼ Dimmers



45323GSR 7- day fully programmable timer switch with timer function and backup. 230V
45348 Light dimmer. 500 W
45348D Light dimmer with built-in intermediate switch. 500 W

Technical alarms

▼ Temperature ▼ Access controls



45389 Electro-mechanical relay for solenoid valve control. 12Vdc
45382G Transformer for 45184/G 230V to 12V
EVG220 Gas shut-off electrovalve
45986 Double-threshold (min./max.) temperature detector. 12V/24V
45378CS Universal badge switch
45378CST Universal badge switch with time delay
45378LC Chip card reader/programmer
45378DF Decoder for chip card reader
45339CHM Chip card master
45339CHU Chip card



AVVERTENZE: le fotografie di alcuni prodotti non rispettano le reali dimensioni. Per una completa descrizione delle caratteristiche dei prodotti e illustrazione dei codici della serie, si prega di consultare il Catalogo General.
WARNING: photographs of some products do not reflect the real dimensions. For a complete description of the characteristics of the products and for the code of the series, please see the "AVE General Catalogue".

Noir AX Die cast plates

▼ Design Makio Hasuike



BX
Bordeaux



CR
Chrome



BM
Navy Blue



TT
Brass



BG
Banquise White



AM
Metallic Silver



GV
Satin Grey



GSM
Metal Dark Grey



GA
Slate Grey



GO
Ochre Yellow



NL
Glossy Black



RD
Briarwood



RF
Ferrari Red



GN
Noir Grey

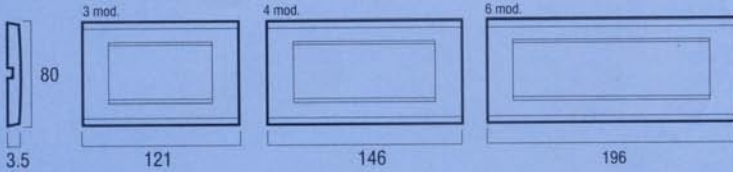

Available in
3, 4 and 6 modules

Banquise Light-up die cast plates

▼ Design Makio Hasuike



BB
Banquise White



RD
Briarwood



NO
Mat Black



CR
Chromerome



OT
Brass



VMC
Mica-Finished Bright
Green



CMC
Champagne



GSM
Metal Dark Grey



BMC
Mica-finished White



GF
Graphite

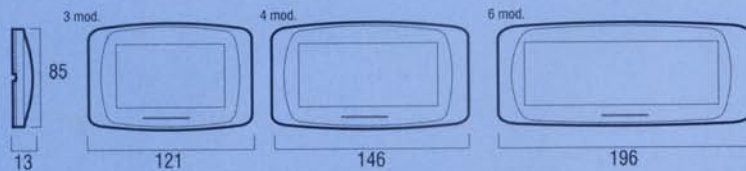

Available in
3, 4 and 6 modules

Technopolymer plates

▼ For round box.



BB
Banquise White



NL
Glossy Black



TW
Teak Wood



PW
Pine Wood

Available in
1, 2, 3, 4 and 6 modules

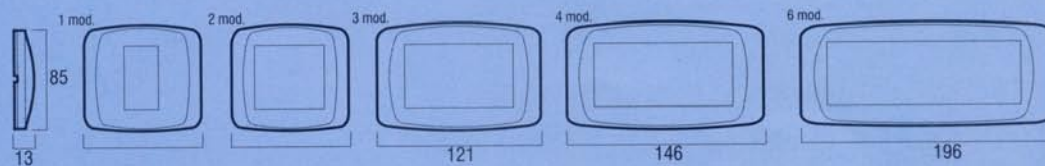

Noir AX

AVVERTENZE: le fotografie di alcuni prodotti non rispettano le reali dimensioni. Per una completa descrizione delle caratteristiche dei prodotti e illustrazione dei codici della serie, si prega di consultare il Catalogo General.
WARNING: photographs of some products do not reflect the real dimensions. For a complete description of the characteristics of the products and for the code of the series, please see the "AVE General Catalogue".

Special plates
 ▼ Maxi module



45P910BG
 Banquise White
45P910GSM
 1Metal Dark Grey
 10 mod.



45PMXBG
 Banquise White
45PMXGSM
 Metal Dark Grey
 1 maxi mod.



45P915BG
 1Banquise White
45P915GSM
 Metal Dark Grey
 15 mod.



45P5MXBG
 Banquise White
45P5MXGSM
 Metal Dark Grey
 5+1maxi mod.



45P10MXBG
 Banquise White
45P10MXGSM
 1Metal Dark Grey
 10+1maxi mod.



45P920BG
 Banquise White
45P920GSM
 1Metal Dark Grey
 20 mod.

Mounting 1 or 2 module devices on 3 module frames
 using blank plates

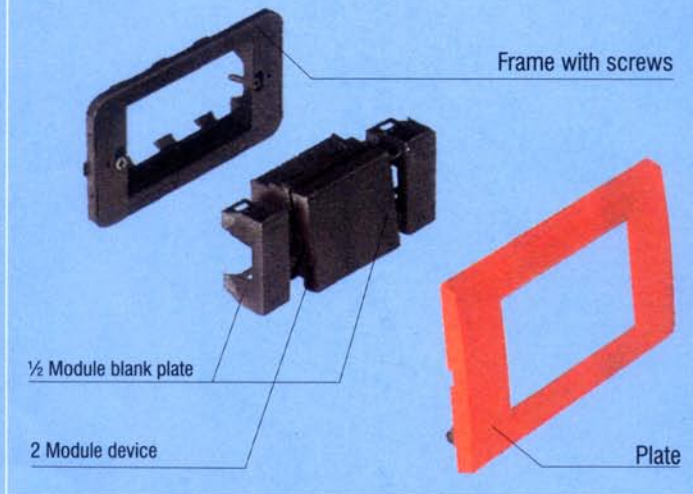

Authorised Distributors :



JAVERI SALES CORPORATION

192, (Old 149), Govindappa St., Chennai-600 001.

☎ 5369716, 5369853, 5384465 Fax : 5363559

e mail : jsc@vsnl.com

Web : www.javeri.com

Ave Anchor Pvt. Ltd.
 PLOT NO. G-9, CROSS RD-A, M.I.D.C.,
 MAROL, ANDHERI(E), MUMBAI-400 093
 Tel.: 6938698, 6938695. Fax: (91-22)6938673.
 e-mail: anchorave@vsnl.in
 Internet: <http://www.anchor-world.com>.

ANCHOR

ave
 INTERRUITORI

An Indo Italian Joint Venture